



**US Army Corps  
of Engineers** \*  
New England District  
696 Virginia Road  
Concord, MA 01742-2751

# PUBLIC NOTICE

**Comment Period Begins:** Oct-05-2010  
**Comment Period Ends:** Nov-03-2010  
**File Number:** NAE-2010-00282  
**In Reply Refer To:** LeeAnn B. Neal  
**Phone:** (207) 623-8367  
**E-mail:** LeeAnn.Neal@usace.army.mil

The District Engineer has received a permit application from the applicant below to **conduct work in waters of the United States** as described below.

**APPLICANT:** Acadia Sea Farms, Inc. 1231 Bar Harbor Road, Trenton, Maine 04605

**ACTIVITY:** Place up to 5,000 OysterGro cages within two twenty five acre tracts below the mean high water line of Goose Cove at Trenton, Maine in order to cultivate American Oyster (*Crassostrea virginica*) and European Flat Oyster (*Ostrea edulis*) as shown on the attached plans entitled "ACADIA SEA FARMS, INC." in 9 sheets dated "01/28/2010".

A detailed description and plans of the activity are attached.

## WATERWAY AND LOCATION OF THE PROPOSED WORK

This work is proposed in Goose Cove at Trenton, Maine. The proposed location of the eastern tract is on the USGS NEWBURY NECK quadrangle sheet; Lat/Long 44.4251250°N; 68.3807199°W. The proposed location of the western tract is on the USGS NEWBURY NECK quadrangle sheet; Lat/Long 44.4208850°N; 68.3835933°W.

## AUTHORITY

Permits are required pursuant to:

- Section 10 of the Rivers and Harbors Act of 1899  
 Section 404 of the Clean Water Act  
 Section 103 of the Marine Protection, Research and Sanctuaries Act).

The decision whether to issue a permit will be based on an evaluation of the probable impact of the proposed activity on the public interest. That decision will reflect the national concern for both protection and utilization of important resources. The benefit which may reasonably accrue from the proposal must be balanced against its reasonably foreseeable detriments. All factors which may be relevant to the proposal will be considered, including the cumulative effects thereof; among those are: conservation, economics, aesthetics, general environmental concerns, wetlands, cultural value, fish and wildlife values, flood hazards, flood plain value, land use, navigation, shoreline erosion and accretion, recreation, water supply and conservation, water quality, energy needs, safety, food production and, in general, the needs and welfare of the people.

The Corps of Engineers is soliciting comments from the public; Federal, state, and local agencies and officials; Indian Tribes; and other interested parties in order to consider and evaluate the impacts of this proposed activity. Any comments received will be considered by the Corps of Engineers to determine whether to issue,

modify, condition or deny a permit for this proposal. To make this decision, comments are used to assess impacts on endangered species, historic properties, water quality, general environmental effects, and the other public interest factors listed above. Comments are used in the preparation of an Environmental Assessment and/or an Environmental Impact Statement pursuant to the National Environmental Policy Act. Comments are also used to determine the need for a public hearing and to determine the overall public interest of the proposed activity.

### **ESSENTIAL FISH HABITAT**

The Magnuson-Stevens Fishery Conservation and Management Act, as amended by the Sustainable Fisheries Act of 1996 (Public Law 104-267), requires all federal agencies to consult with the National Marine Fisheries Service on all actions, or proposed actions, permitted, funded, or undertaken by the agency, that may adversely affect Essential Fish Habitat (EFH).

This work may impact 50 acres of Essential Fish Habitat (EFH). See attached sheet 5 for the list of species and life stages. The habitat within the eastern tract is generally flat with a consistent depth of 15 feet and consisting of tidal bottom composed of soft mud with a rare rock outcropping near the northeast corner. Past the northeast corner, the sediments began to harden to a mix of mud and gravel. No eelgrass was observed within the eastern tract boundary. The habitat within the western tract consisted of extraordinarily soft sediments and consistent depths of 19 feet. No rock outcrops or aquatic vegetation were observed. The proposed project is expected to have only short-term impacts on fish. During the placement of anchors/blocks, long lines and cages, fish in the project area may be displaced by suspended sediments and noise.

The District Engineer has made a preliminary determination that the site-specific adverse effect will not be substantial. Further consultation with the National Marine Fisheries Service regarding EFH conservation recommendations is being conducted and will be concluded prior to the final decision.

### **SECTION 106 COORDINATION**

Based on his initial review, the District Engineer has determined that the proposed work may impact properties listed in, or eligible for listing in, the National Register of Historic Places. Additional review and consultation to fulfil requirements under Section 106 of the National Historic Preservation Act of 1966, as amended, will be ongoing as part of the permit review process.

### **ENDANGERED SPECIES CONSULTATION**

The New England District, Army Corps of Engineers has reviewed the list of species protected under the Endangered Species Act of 1973, as amended, which might occur at the project site. It is our preliminary determination that the proposed activity for which authorization is being sought is designed, situated or will be operated/used in such a manner that it is not likely to adversely affect any Federally listed endangered or threatened species or their designated critical habitat. By this Public Notice, we are requesting that the appropriate Federal Agency concur with our determination.

The States of Connecticut, Maine, Massachusetts, New Hampshire and Rhode Island have approved **Coastal Zone Management Programs**. Where applicable the applicant states that any proposed activity will comply with and will be conducted in a manner that is consistent with the approved Coastal Zone Management Program. By this Public Notice, we are requesting the State concurrence or objection to the applicant's consistency statement.

CENAE-R

FILE NO. NAE-2010-00282

The following authorizations have been applied for, or have been, or will be obtained:

- ( X ) Permit, License or Assent from State.
- ( ) Permit from Local Wetland Agency or Conservation Commission.
- ( ) Water Quality Certification in accordance with Section 401 of the Clean Water Act.

In order to properly evaluate the proposal, we are seeking public comment. Anyone wishing to comment is encouraged to do so. **Comments should be submitted in writing by the above date.** If you have any questions, please contact LeeAnn B. Neal at (207) 623-8367 at our Manchester, Maine Project Office.

Any person may request, in writing, within the comment period specified in this notice, that a public hearing be held to consider the application. Requests for a public hearing shall specifically state the reasons for holding a public hearing. The Corps holds public hearings for the purpose of obtaining public comments when that is the best means for understanding a wide variety of concerns from a diverse segment of the public.

The initial determinations made herein will be reviewed in light of facts submitted in response to this notice. All comments will be considered a matter of public record. Copies of letters of objection will be forwarded to the applicant who will normally be requested to contact objectors directly in an effort to reach an understanding.

In accordance with 33 CFR 325.2(a)(8), we publish monthly a list of permits issued or denied during the previous month at [www.nae.usace.army.mil/reg](http://www.nae.usace.army.mil/reg), under the heading "Monthly General and Individual Permit Authorizations." Relevant environmental documents and the SOFs or RODs are available upon written request and, where applicable, upon the payment of administrative fees. Also visit [www.nae.usace.army.mil](http://www.nae.usace.army.mil) for more information on the New England District Corps of Engineers programs.

**THIS NOTICE IS NOT AN AUTHORIZATION TO DO ANY WORK.**

**Frank J. Del Giudice  
Chief, Permits and Enforcement Branch  
Regulatory Division**

If you would prefer not to continue receiving Public Notices, please contact Ms. Tina Chaisson at (978) 318-8058 or e-mail her at [bettina.m.chaisson@usace.army.mil](mailto:bettina.m.chaisson@usace.army.mil). You may also check here ( ) and return this portion of the Public Notice to: Bettina Chaisson, Regulatory Division, U.S. Army Corps of Engineers, 696 Virginia Road, Concord, MA 01742-2751.

NAME: \_\_\_\_\_

ADDRESS: \_\_\_\_\_

**PROPOSED WORK AND PURPOSE**

The proposed project includes work in navigable waters for the cultivation of American oysters (*Crassostrea virginica*) and European flat oysters (*Ostrea edulis*) in conjunction with a ten year suspended and bottom culture aquaculture facility. The project area encompasses two-twenty five acre tracts (for a total of fifty acres) below the mean high water line of Goose Cove at Trenton, Maine. The eastern tract measures approximately 1594' x 689' x 1633' x 656' and will include up to twenty three lines of one hundred eight cages per line, in strings of ten cages located approximately twenty eight feet apart; the western tract measures approximately 1895' x 606.8' x 1905.7' x 544.5' and will include up to nineteen lines of one hundred thirty two cages per line in strings of ten cages located approximately twenty eight feet apart for a total of up to five thousand 58"x36"x6" OysterGro cages between the two tracts.

The lines would be either floating or submerged dependent on growing conditions, and will be moored by one *hundred pound mushroom anchors and/or one hundred fifty pound concrete blocks*, one at each end of a string of cages, secured by one half-inch polysteel sink rope.

The lines and cages would be serviced by one or two fourteen foot Carolina skiffs and one thirty foot motorized barge.

**Summary of Essential Fish Habitat (EFH) Designation****100 x 100 Square Coordinates:**

Boundary	North	East	South	West
Coordinate	44° 30.0' N	68° 20.0' W	44° 20.0' N	68° 30.0' W

**Square Description (i.e. habitat, landmarks, coastline markers):** Waters within the square within Blue Hill Bay affecting the following: the northwest quarter of Mount Desert Island, the northeast part of Long Island, the northern part of Bartlett Island, and Newbury Neck, from Morgan Bay to Old Point including Trenton, ME., eastern Lamoine, ME., Surry, ME., Alley I., Thomas I., and the Mount Desert Narrows. Other features affected by these waters include: the Jordan River, Bar Harbor Airport, Union River Bay, Western Bay, Northwest Cove, Black I., Green I., Pretty Marsh Harbor, Bartlett Narrows, Hopkins Pt, South Surry, ME., Burnt Pt., and High Head on Newbury Neck, Jed Is., Conary Nub, Morgan Bay, Patten Bay east of Surry, ME., Tupper Ledge, and Weymouth Pt. at the entrance to the Union River.

Species	Eggs	Larvae	Juveniles	Adults
Atlantic salmon ( <i>Salmo salar</i> )			X	X
Atlantic cod ( <i>Gadus morhua</i> )	X	X	X	X
haddock ( <i>Melanogrammus aeglefinus</i> )				
pollock ( <i>Pollachius virens</i> )			X	
whiting ( <i>Merluccius bilinearis</i> )			X	X
offshore hake ( <i>Merluccius albidus</i> )				
red hake ( <i>Urophycis chuss</i> )			X	X
white hake ( <i>Urophycis tenuis</i> )			X	X
redfish ( <i>Sebastes fasciatus</i> )	n/a			
witch flounder ( <i>Glyptocephalus cynoglossus</i> )				
winter flounder ( <i>Pleuronectes americanus</i> )	X	X	X	X
yellowtail flounder ( <i>Pleuronectes ferruginea</i> )	X	X		
windowpane flounder ( <i>Scopthalmus aquosus</i> )	X	X	X	X
American plaice ( <i>Hippoglossoides platessoides</i> )	X	X	X	X
ocean pout ( <i>Macrozoarces americanus</i> )	X	X	X	X
Atlantic halibut ( <i>Hippoglossus hippoglossus</i> )				
Atlantic sea scallop ( <i>Placopecten magellanicus</i> )	X	X	X	X
Atlantic sea herring ( <i>Clupea harengus</i> )		X	X	X
monkfish ( <i>Lophius americanus</i> )				

bluefish ( <i>Pomatomus saltatrix</i> )				
long finned squid ( <i>Loligo pealei</i> )	n/a	n/a		
short finned squid ( <i>Illex illecebrosus</i> )	n/a	n/a		
Atlantic butterfish ( <i>Peprilus triacanthus</i> )				
Atlantic mackerel ( <i>Scomber scombrus</i> )				X
summer flounder ( <i>Paralichthys dentatus</i> )				
scup ( <i>Stenotomus chrysops</i> )	n/a	n/a		
black sea bass ( <i>Centropristus striata</i> )	n/a			
surf clam ( <i>Spisula solidissima</i> )	n/a	n/a		
ocean quahog ( <i>Arctica islandica</i> )	n/a	n/a		
spiny dogfish ( <i>Squalus acanthias</i> )	n/a	n/a		
tilefish ( <i>Lopholatilus chamaeleonticeps</i> )				
bluefin tuna ( <i>Thunnus thynnus</i> )				X

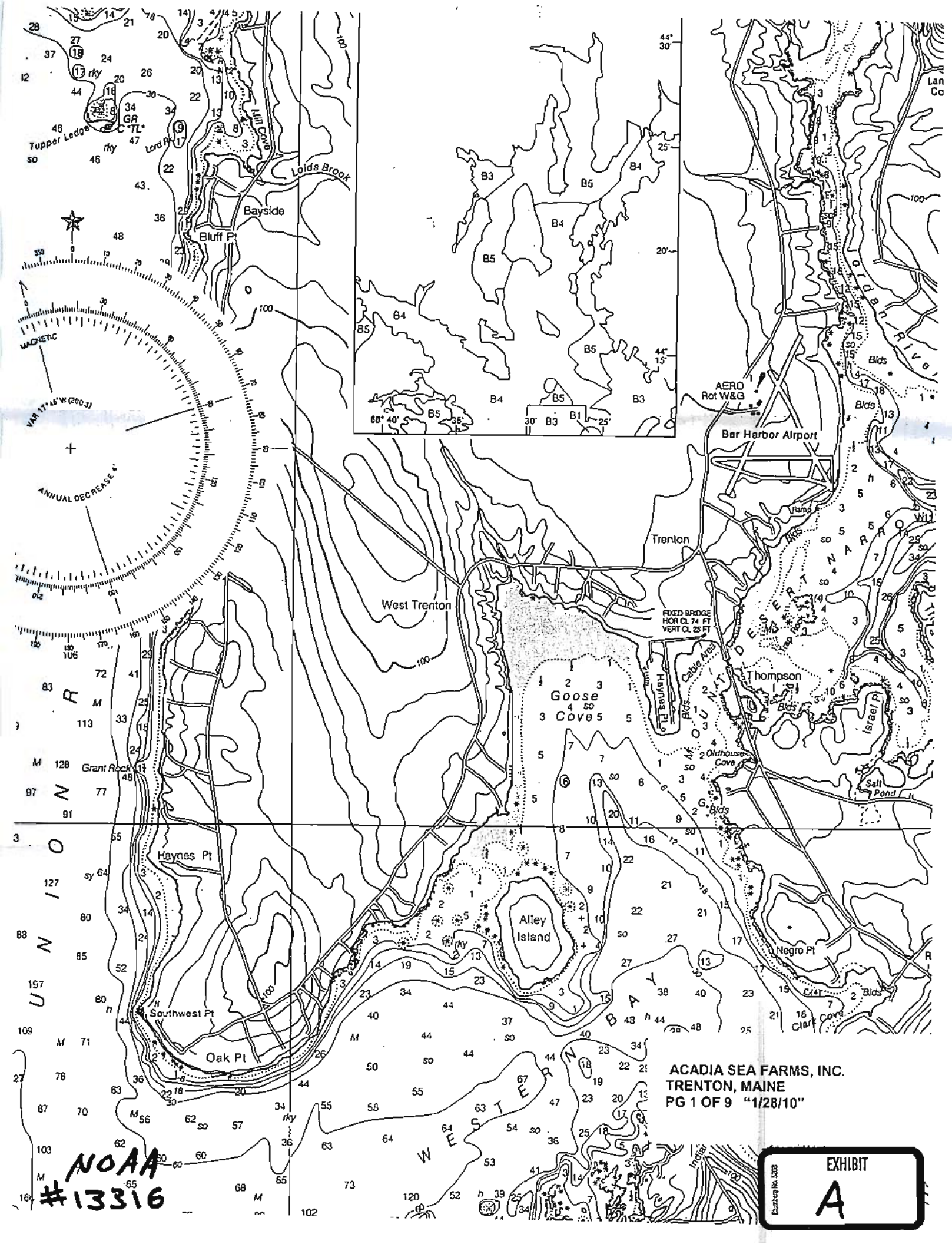

ACADIA SEA FARMS, INC.  
 TRENTON, MAINE  
 PG 1 OF 9 "1/28/10"

NOAA  
 #13316

EXHIBIT  
 A





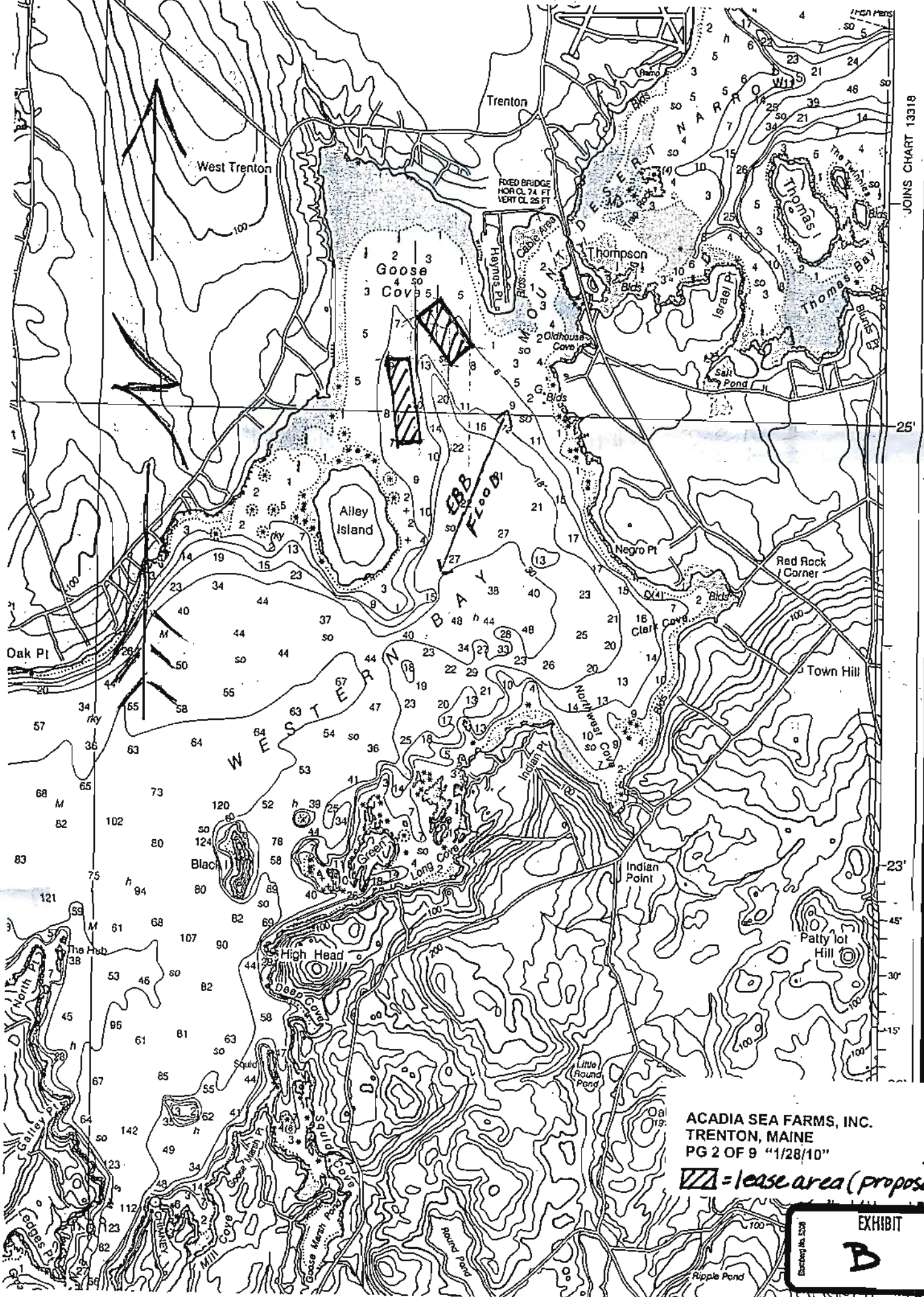

JOINS CHART 1331B

NOAA # 1331C 1:40,000

ACADIA SEA FARMS, INC.  
TRENTON, MAINE  
PG 2 OF 9 "1/28/10"

 = lease area (proposed)

EXHIBIT  
**B**

Barber No. 2300

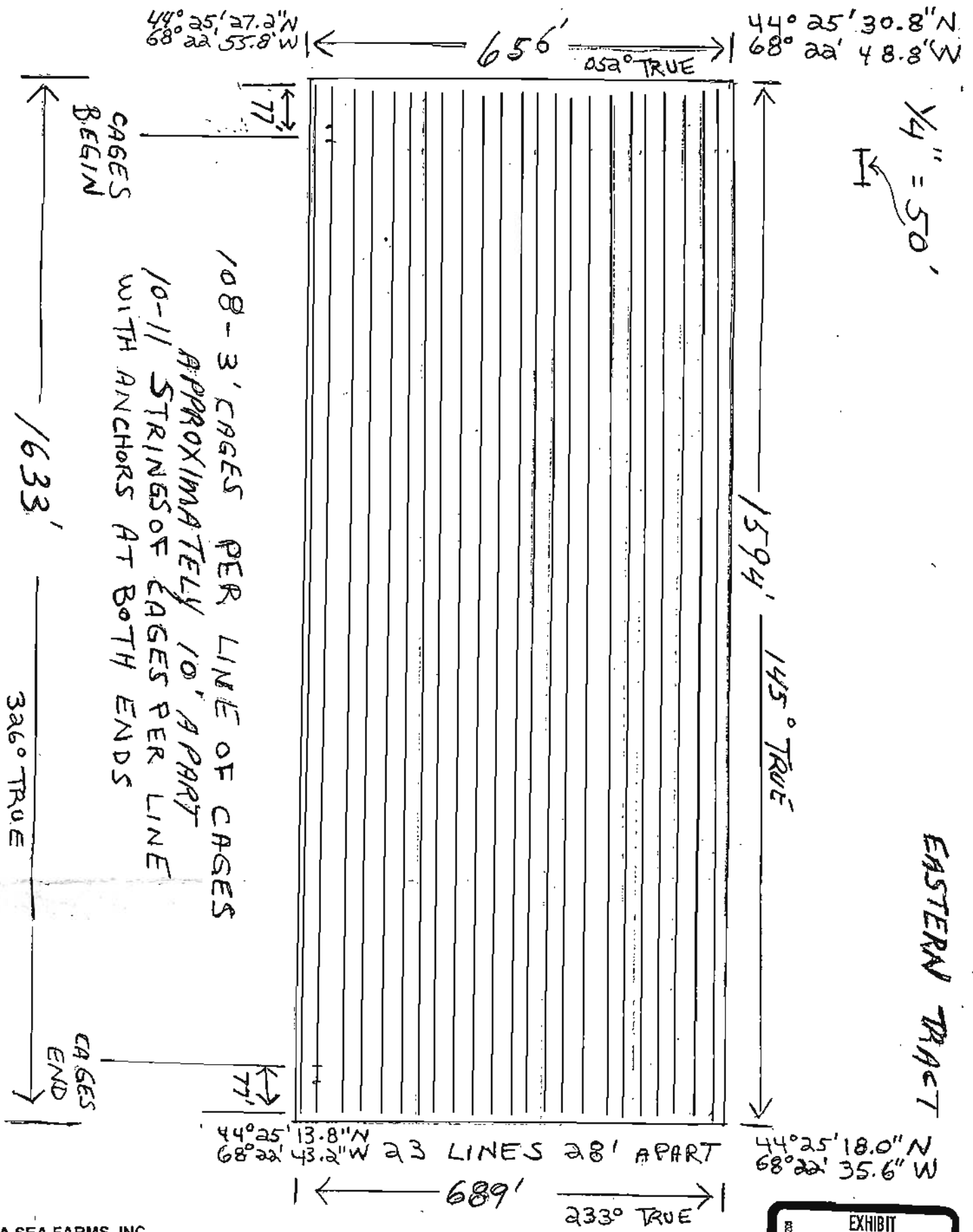

1/4" = 50'

WESTERN TRACT

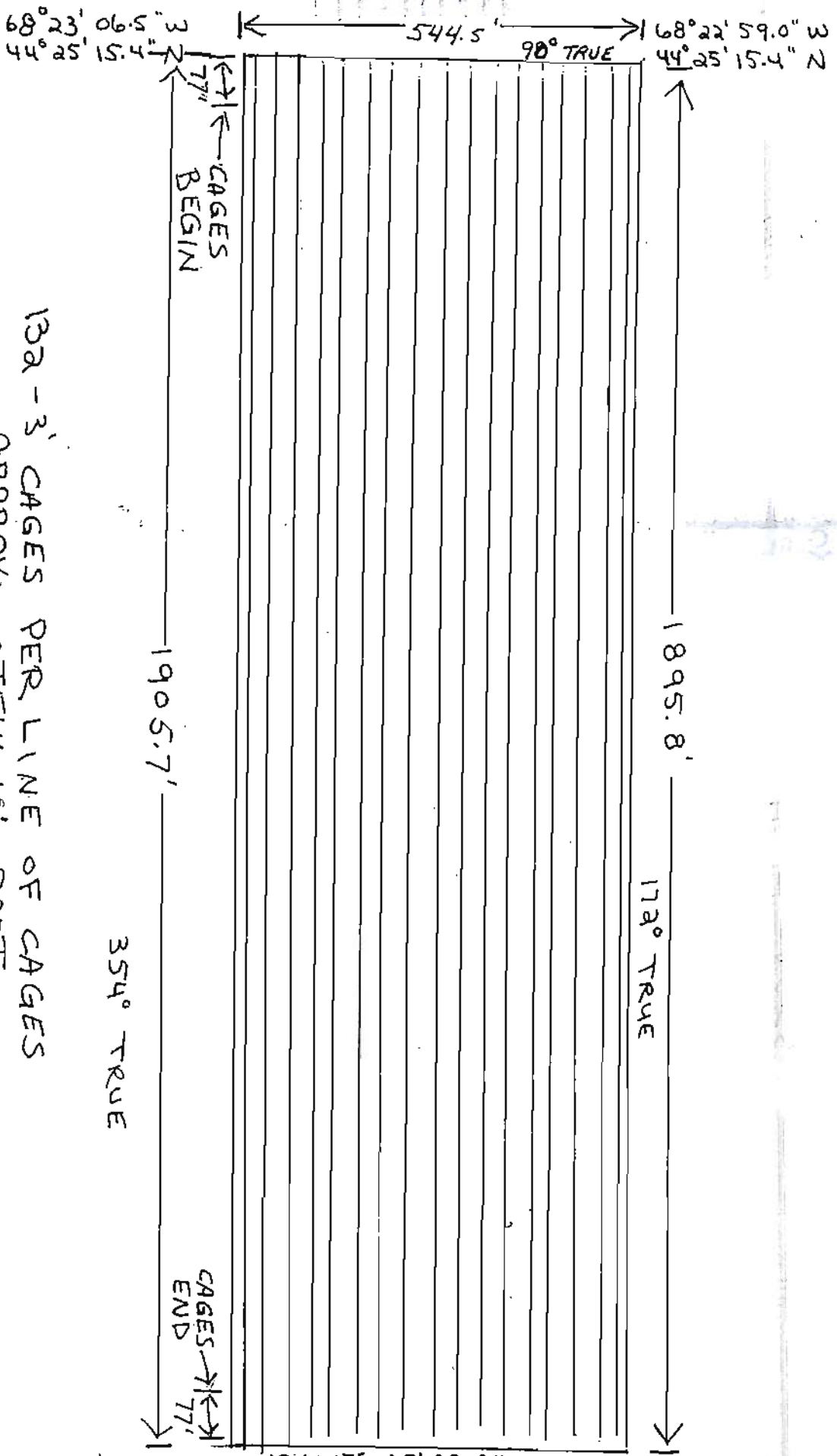

132-3' CAGES PER LINE OF CAGES  
APPROXIMATELY 10' APART  
13-14 STRINGS OF CAGES PER LINE  
WITH ANCHORS AT BOTH ENDS

EXHIBIT  
U  
Survey No. 2003

68° 23' 03.9" W 3 2  
44° 24' 56.7" N  
19 LINES 28' APART  
606.8'  
268° TRUE  
68° 22' 55.6" W  
44° 24' 56.9" N

WESTERN TRACT

1/4" = 50'

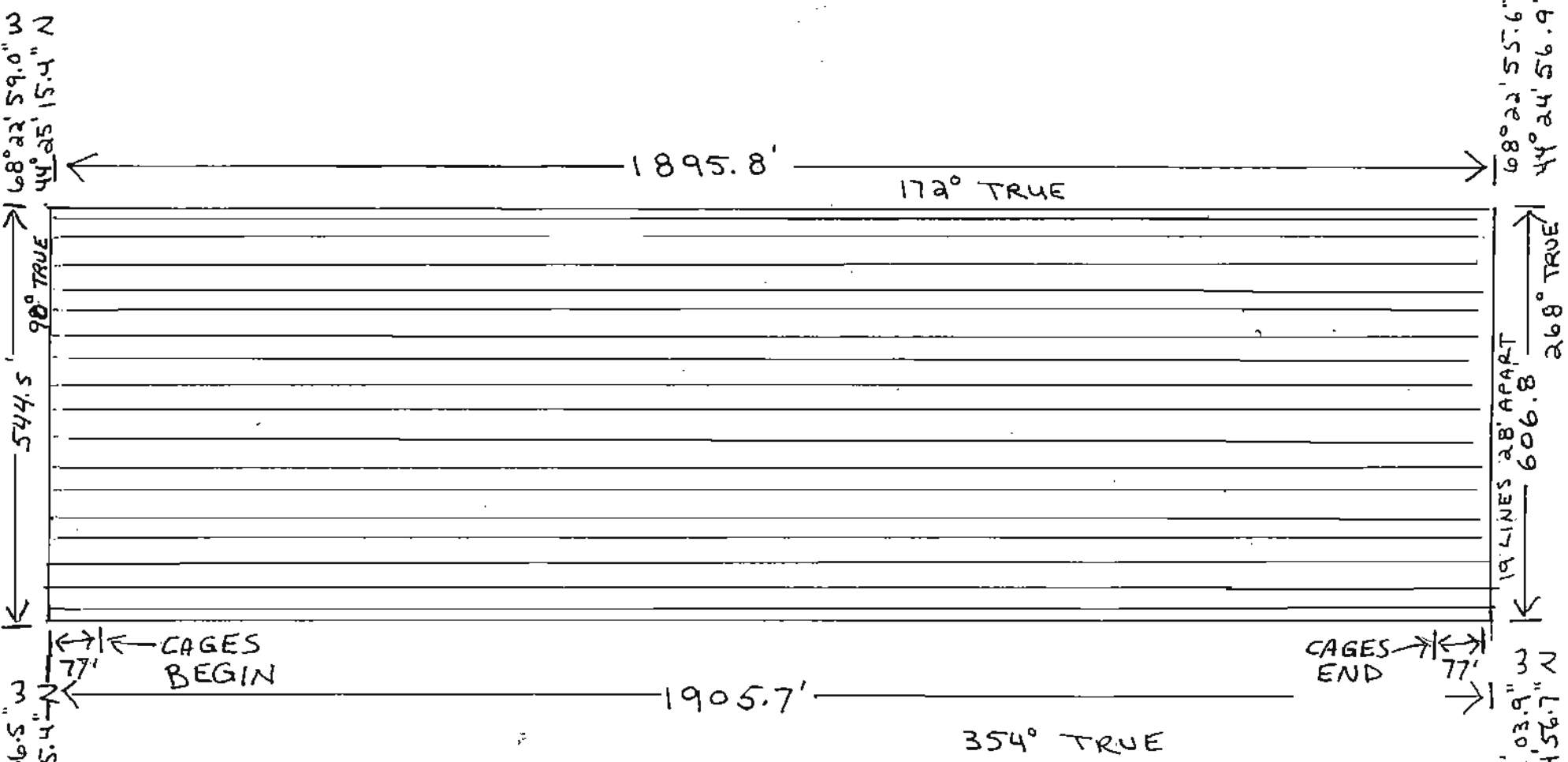

132 - 3' CAGES PER LINE OF CAGES  
 APPROXIMATELY 10' APART  
 13-14 STRINGS OF CAGES PER LINE  
 WITH ANCHORS AT BOTH ENDS

ACADIA SEA FARMS, INC.  
 TRENTON, MAINE  
 PG 4 OF 8 "1/28/10"

EXHIBIT  
 C

[HOME](#) | [ABOUT US](#) | [SUPPORT](#) | [DOWNLOADS](#) | [CONTACT US](#) | [FRANCAIS](#) |

# OysterGro

THE COMPLETE FARMING SYSTEM

**WHAT?** | **HOW?** | **WHO?** | **WHY?**

[Overview](#)  
[Components](#)

[Specifications](#)

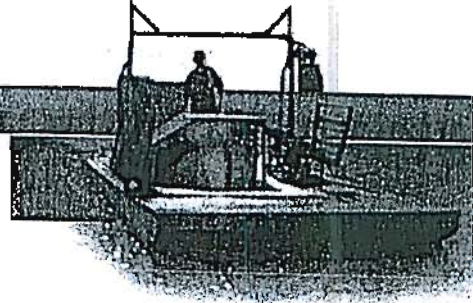

Learn **WHAT** the OysterGro™ System is All About

→ Overview

OysterGro™ consists of a compact housing with floats that provide the versatility, efficiency and effectiveness on which business success depends. Every component is designed for strength, durability and convenience.

→ Components

Large easily removable caps on each end.

The cage accommodates six Vexar oyster bags on two levels.

Polyethylene main and secondary rope lines make mechanized handling feasible.

Drawer design makes access and handling fast and easy.

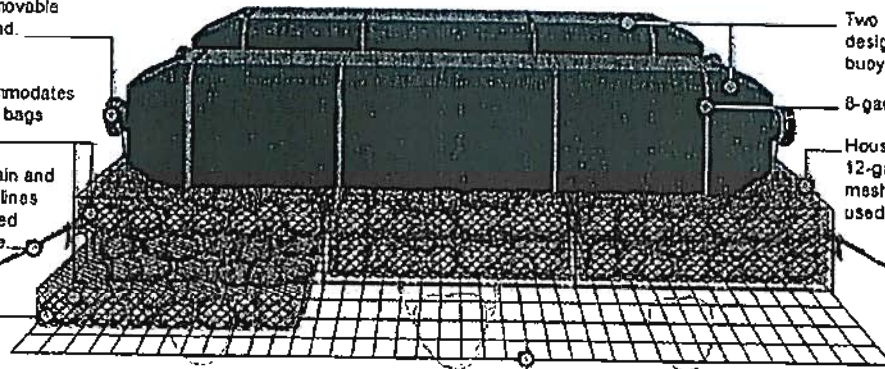

Two airtight floats specifically designed to reach optimum buoyancy for feeding depth.

8-gauge wire.

Housing constructed of 12-gauge vinyl-coated wire mesh — the same material used for lobster traps.

Secure anchoring system provides stability in all types of weather conditions.

Door allows for quick access to oyster bags.

→ Specifications (width x depth x height)

Housing Cage: 58" x 36" x 6" (147.3 cm x 91.4 cm x 15.2 cm)

Buoy: 58" x 11" x 8" (147.3 cm x 27.9 cm x 20.3 cm)

Vexar bags: 18" x 35" x 3" (45.7 cm x 88.9 cm x 7.6 cm) approx.

[HOME](#) | [WHAT?](#) | [HOW?](#) | [WHO?](#) | [WHY?](#) | [ABOUT US](#) | [SUPPORT](#) |  
[DOWNLOADS](#) | [CONTACT US](#) |

OysterGro © 2010 | All Rights Reserved

ACADIA SEA FARMS, INC.  
TRENTON, MAINE  
PG 5 OF 9 "1/28/10"



A: Single Structure Top View

D: Mooring System Cross Section

THE COMPLETE FARMING SYSTEM



www.oystergro.com

Figure III – OysterGro rope system

These diagrams show the rope system.

For water dept of 7' to 12' (ideal depth)

- Calm / protected area: 12 cages / line
- Windy area: 10 cages / line

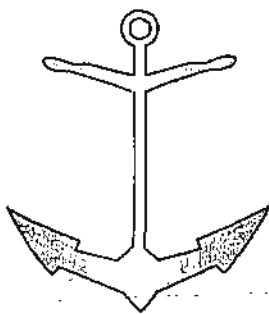
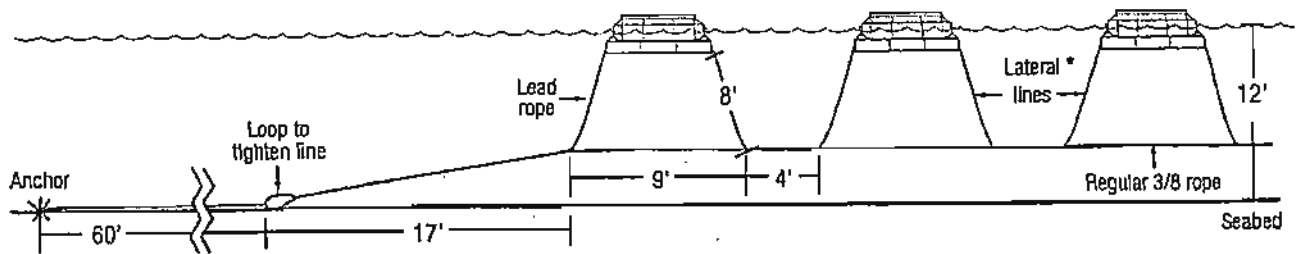

Marine Anchor

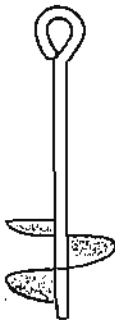

Screw Anchor

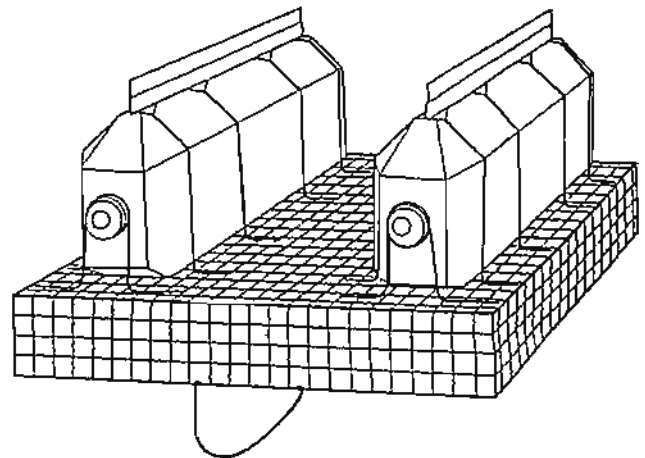

Rope bridle on each ends.

\*Lateral lines are attached to rope bridle

Revised date: 04/13/09



A: Single Structure Top View

D: Mooring System Cross Section

THE COMPLETE FARMING SYSTEM



www.oystergro.com

Figure III – OysterGro rope system

These diagrams show the rope system.

For water dept of 7' to 12' (Ideal depth)

- Calm / protected area: 12 cages / line
- Windy area: 10 cages / line

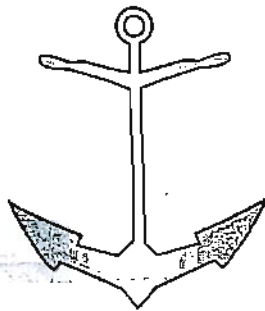
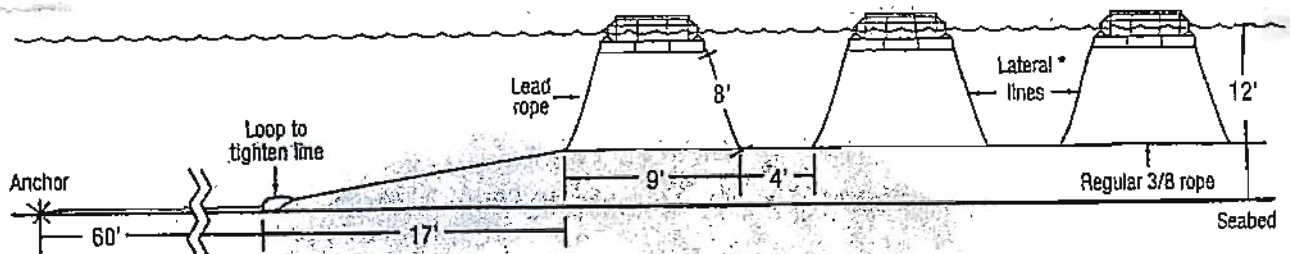

Marine Anchor

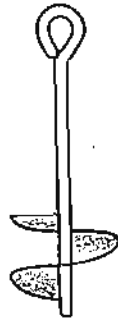

Screw Anchor

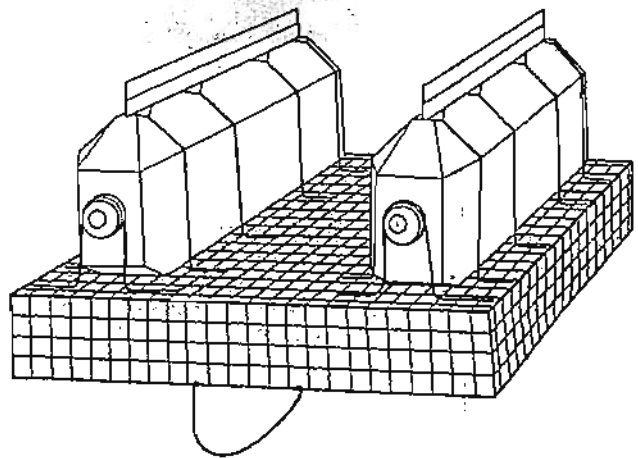

Rope bridge on each ends.

\*Lateral lines are attached to rope bridge

ACADIA SEA FARMS, INC.  
TRENTON, MAINE  
PG 6 OF 9 "1/28/10"

Revised date: 04/13/09



## Layout of Long Lines

A typical long line consists of one individual row of 10 to 12 OysterGro Units (view figure II). The units are linked together with 3/8" ropes (view figure III). Proper anchorage is necessary to hold the units to the seabed. A long line is about 160 ft long and rule of thumb, 100 OysterGro cages can be set on a one-acre lot.

The distance between the long lines must be sufficient to allow for navigation and to provide easy access when tending to the cages - 28 feet is suggested.

Bouctouche Bay Industries Ltd will supply a rope kit to new growers. This kit can be used as a model.

Figure II - Long lines

This figure shows the layout of 3 - 10 OysterGro cages long lines on the water surface.

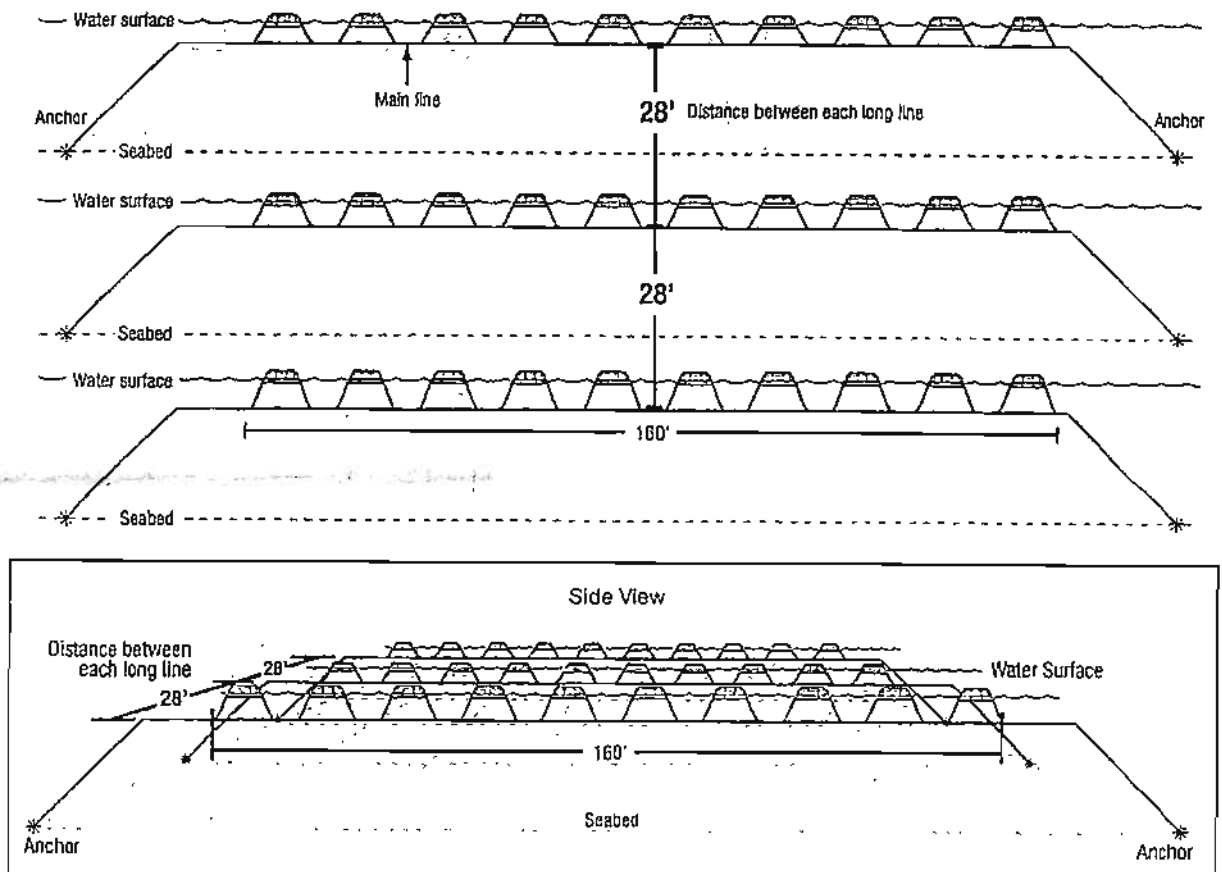

Revised date: 04/13/09



ENLARGEMENT OF  
CAGE LAYOUT

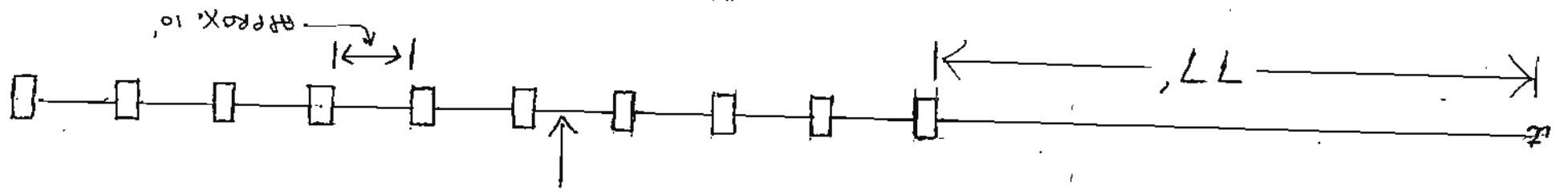
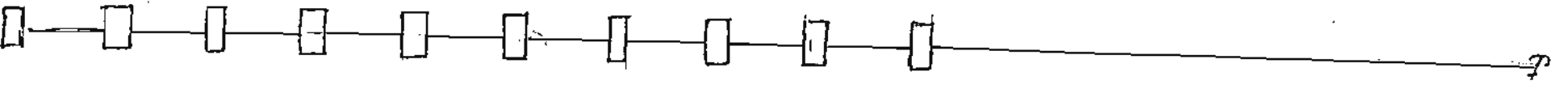
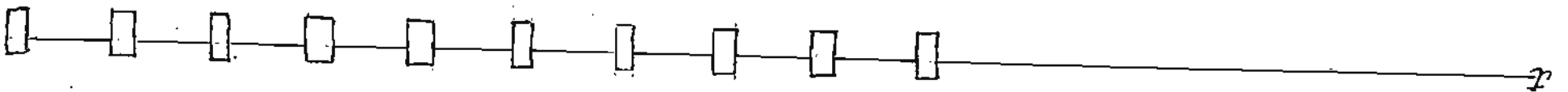
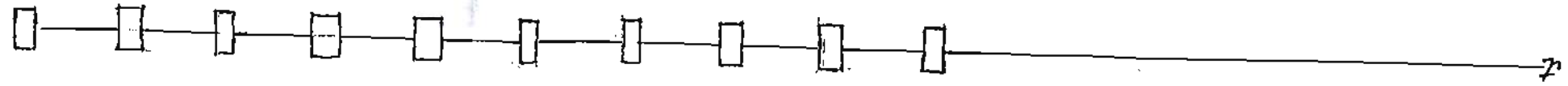

CAGE 58" X 36" X 6"

1/4" = 5'



## Layout of Long Lines

A typical long line consists of one individual row of 10 to 12 OysterGro Units (view figure II). The units are linked together with 3/8" ropes (view figure III). Proper anchorage is necessary to hold the units to the seabed. A long line is about 160 ft long and rule of thumb, 100 OysterGro cages can be set on a one-acre lot.

The distance between the long lines must be sufficient to allow for navigation and to provide easy access when tending to the cages - 28 feet is suggested.

Bouctouche Bay Industries Ltd will supply a rope kit to new growers. This kit can be used as a model.

Figure II - Long lines

This figure shows the layout of 3 - 10 OysterGro cages long lines on the water surface.

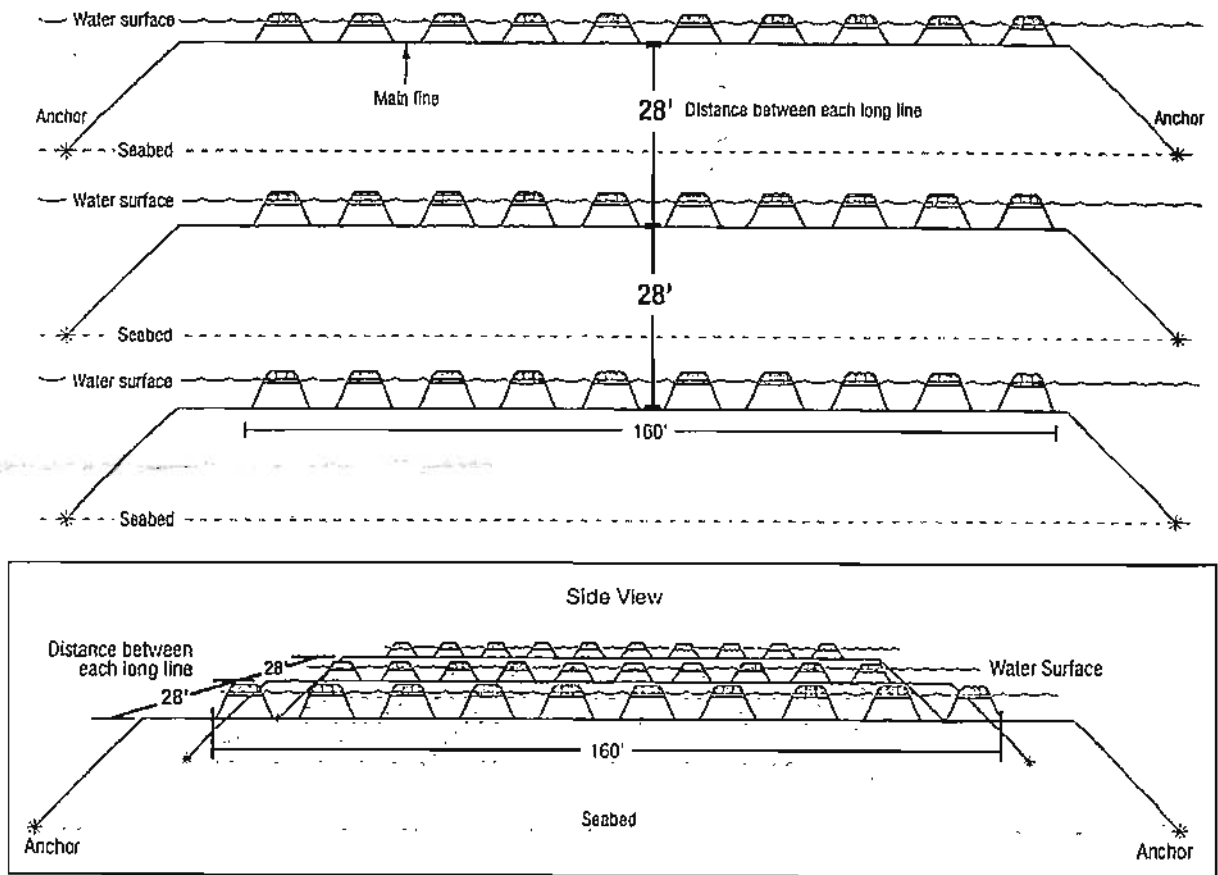

Revised date: 04/13/09

(NOT TO SCALE)

DEPICTS OVERLAP OF ANCHORS AT THE ENDS  
OF TEN STRINGS OF  
FLOATING CAGES

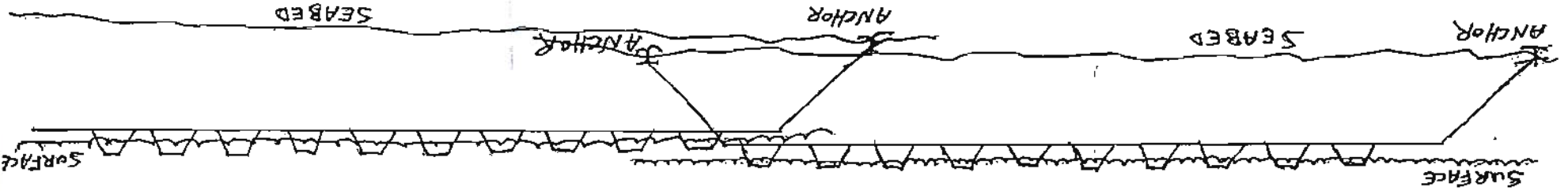

DEPICTS CAGES ON BOTTOM WITH NO ANCHORS

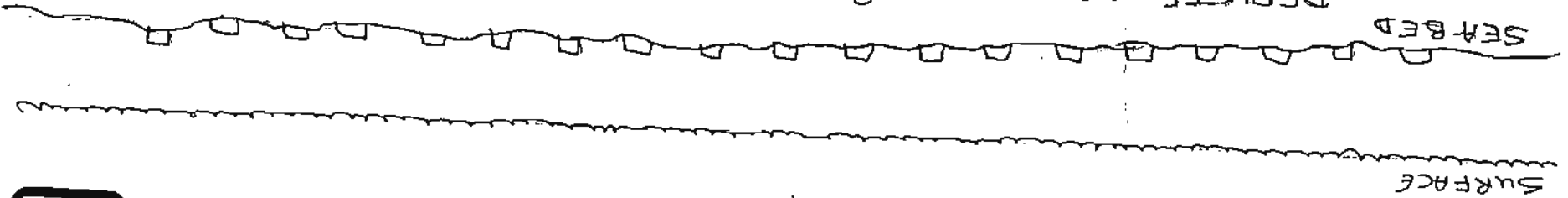

One hundred pound mushroom anchors and/or one hundred fifty pound concrete blocks will be used at both ends of a ten-cage string. Start-up is expected to consist of 50 ten-cage strings and a maximum of 250 10-cage strings at maximum production on each of the two tracts. The cages will winter on bottom and may be floated for summer growth. If the cages are floated, the depth to sea-floor relative to MLW is approximately 5-10 feet and relative to MHW is approximately 16-21, depending on location on the lease.

